Station Information Report

Solar and Meteorological Station

World Bank – Narok, Kenya



Revision	Date	Author	Checked	Approved	Comments
Rev 0	18 Dec 2019	M. King	M. de Jager	M. de Jager	First Issue
Rev 1	30 Jan 2020	M. King	M. de Jager	M. de Jager	WB Comments
Rev 2					

Contents

1	Introduction	4
2	Station Summary	6
3	Map of area.....	7
4	Site layout.....	8
5	Instrument list, serial numbers and multipliers.....	10
6	Supporting hardware and communication peripherals.....	11
7	Data logger wiring	12
8	Power circuit diagram.....	14
9	Detail Photographs	15
10	Terrain Photographs.....	22
11	Station Photographs.....	29
12	Calibration Certificates	36

1 Introduction

NOTE: This project occurred during the COVID19 pandemic outbreak. Any impact on the data quality as a result of the pandemic will be recorded in the monthly quality feedback report alongside other noteworthy events for the affected month.

The World Bank initiated a project with funding from the Energy Sector Management Assistance Program (ESMAP) to, amongst others, support the East African Power Pool (EAPP) in doing renewable energy resource assessments. The focus for this particular section of the project is to get high quality bankable irradiance measurements, high quality supporting meteorological measurements and to promote the awareness of the resource potential of solar energy.

The project is orientated around sites considered for large-scale solar power plant development in the near future. The on-site measured data generated from this project for the applicable term is to be used in conjunction with overlapping and historic satellite derived data for the same location in order to generate a bankable data set, subsequently providing enhanced data accuracy for locations where there may be substantial project investments. The data complements the global resource data available for free via the Global Solar Atlas (<https://globalsolaratlas.info>).

GeoSUN Africa has been awarded the contract to execute the on-site measurement related aspects of the project. The assignment for GeoSUN Africa is the following:

- An inception mission which involves visiting the proposed site locations and selecting the optimal location for the measurement equipment. The outcome of this inception mission is this implementation plan where sites and stations tiers are proposed;
- Providing high quality measuring equipment for each site, in line with the technical specifications;
- Installation of measurement equipment as well as subsequent Site Installation Report and photographs for each site;
- Hosting and providing two years of high quality, 'bankable' meteorological data relevant for solar resource assessment and project development, including upload to an 'open data' platform for public dissemination;
- Ensuring maintenance, security, local cleaning/caretaking, and mitigation against extreme weather events and corrosion;
- Ensuring strong local involvement and capacity building at all stages of the measurement campaign;
- Decommissioning of all sites at the end of the measurement campaign, unless separate arrangements are made with one or more host institutions to continue with measurements outside of this assignment/contract.

This document acts as the Site Installation Report which follows the commissioning of the site, outlining the site location, site characteristics, technical specifications, calibration procedures, and all other relevant information to allow data users to fully understand the site and ensure the bankability of the measurement data. The Site Installation Report is contains photographs of the site and the surrounding terrain.

The measurement data from the site will be continuously transferred to GeoSUN's central data repository, and shall then be transferred to the World Bank on a monthly basis in both raw and

quality controlled formats according to the specifications developed by ESMAP. This data will be delivered via an online file sharing platform one month in arrears. Site Measurement Reports will accompany the delivery of monthly data, and shall detail any issues with the site or equipment, field calibration procedure, and any notable conclusions or results. The World Bank and key client counterparts shall also be provided with access to the vendor's data repository or monitoring platform for real-time analysis.

The assignment shall be deemed completed once two years of concurrent data is delivered in compliance with the minimum data recovery rates specified. At this point the vendor shall decommission each site and remove the solar measurement equipment, unless alternative arrangements outside the scope of this assignment/contract are made and endorsed by the relevant client/host agency.

2 Station Summary

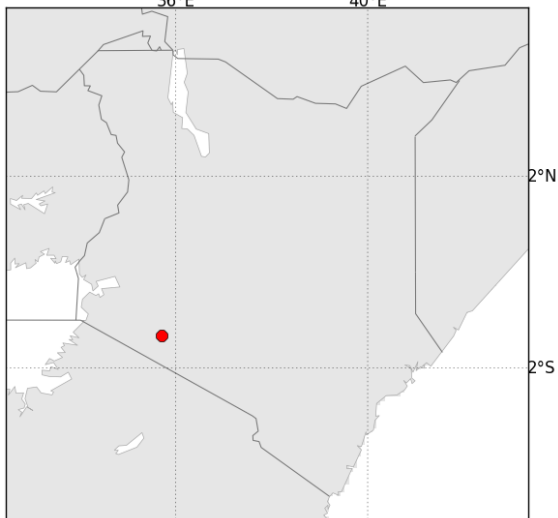
Work performed	Installation and commissioning of solar and meteorological measurement station including security fence.
Commissioning date	3 December 2019
Planned decommissioning date	3 December 2021
Client	World Bank
Client contact person and contact details	<p>Name: Abdul Rahim Jalloh Email: Abduljay@gmail.com Telephone: + 1 301 825 1628</p> <p>Name: Chiara Rogate Email: crogate@worldbank.org Telephone: +1 202 250 0568</p> <p>Name: Willis Ochieng Email: wochieng@kengen.co.ke Telephone: +254 711 036 000</p>
Site location	<p>184 km west of Nairobi, Kenya. 40 km south west of the town of Narok, Kenya.</p> 
Access	Starting in Narok, drive on the B3 heading east, turn left onto the C12 heading south east. Continue along this road for 16 km and turn left onto the road toward Maji Moto. The turnoff to the station is 6 km down this road on the left. The station is located on the Northern side of the Enkare Nairowua Girls Secondary school grounds.
Coordinates	01° 19' 15.95" S, 35° 42' 20.55" E (-1.321097, 35.705708)
Elevation	1914 m AMSL
Time zone (local and data logger)	GMT +3 local time zone
Name and contact details of on-site contact person(s)	Name: Keringot Oloibormongi Cell: +254 706 609 527

3 Map of area



Figure 1: Map of the surrounding area (Source: Google Earth)

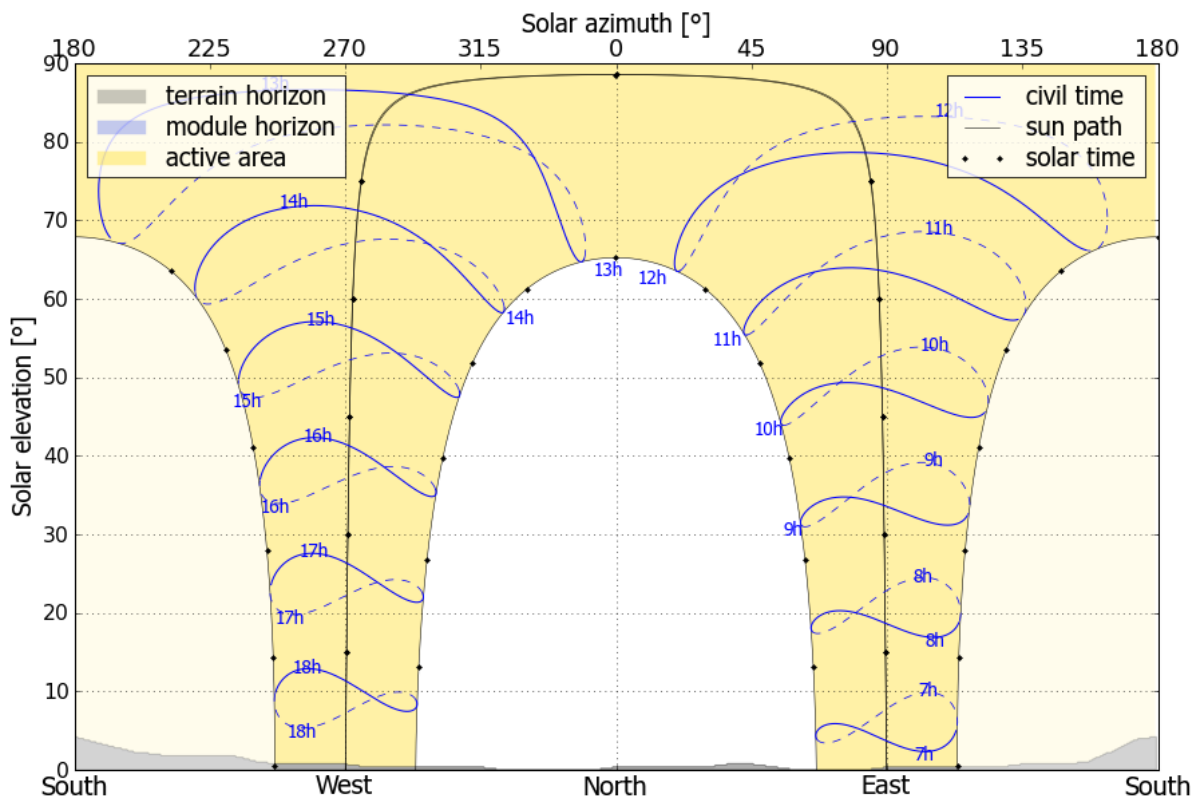

Figure 2: Terrain horizon and day length (Source: Solargis)

4 Site layout

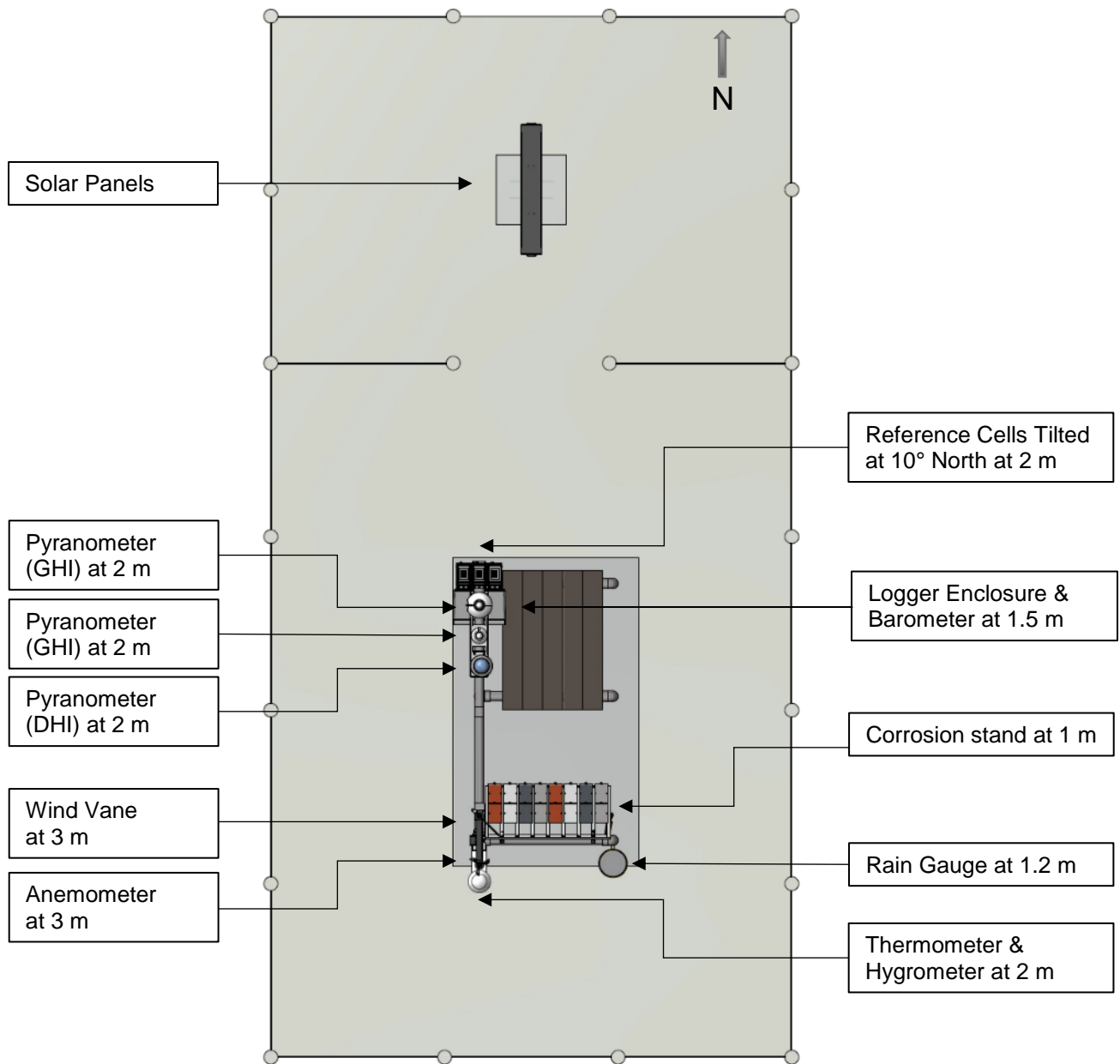

Figure 3: Site Layout (plan view)



Figure 4: Site Layout (perspective view)

5 Instrument list, serial numbers and multipliers

Instrument (Measurement)	Make and Model	Serial Number	Variable Name (Program)	Multiplier
Pyranometer (GHI)	Hukseflux SR20-T2	7276	GHI_1	13.26 $\mu\text{V/W/m}^2$
Pyranometer (GHI)	Kipp & Zonen CMP 11	128639	GHI_2	8.30 $\mu\text{V/W/m}^2$
Pyranometer (DHI)	Delta Electronics SPN 1	A1703	DHI_SPN1	1
Reference Cell Clean	Ingenieurbüro Si-mV-85-A	85-00205-17-19350111	RefCellClean	57.85 $\mu\text{V/W/m}^2$
Reference Cell Monthly	Ingenieurbüro Si-mV-85-A	85-00205-17-19350112	RefCellMonthly	57.73 $\mu\text{V/W/m}^2$
Reference Cell Dirty	Ingenieurbüro Si-mV-85-A	85-00205-17-19350113	RefCellDirty	58.47 $\mu\text{V/W/m}^2$
3-Cup Anemometer (Wind speed)	Met One 014A	U11172	WSpd	0.447 Offset 0.8 Slope
Wind Vane (Wind Direction)	Met One 024A	U11205	WDir	0 Offset 742.067912 Slope
Temperature Sensor (Ambient Temperature)	Campbell Scientific CS215	E11086	Temp	1
Relative humidity Sensor (Relative Humidity)	Campbell Scientific CS215	E11086	RH	1
Barometer (Atmospheric Pressure)	Vaisala PTB110	K2610011	BP	500 offset 0.24 slope
Rain Gauge (Rain)	Texas Electronics TR-525I	56803-813	Rain	0.2 mm/tip
Corrosion Plate	Make	Sample	Position (Column, Row)	Mass (g)
Mild Steel plate (Corrosion Testing)	Orytech Mild Steel	I5	C1, R1	128.1795
		I6	C1, R2	169.1079
		J1	C6, R1	135.8469
		J2	C6, R2	135.5915
H.D. Galvanised (Zinc) plate (Corrosion Testing)	Orytech H.D. Galvanised (Zinc)	I5	C2, R1	79.3946
		I6	C2, R2	80.2965
		J1	C5, R1	80.5741
		J2	C5, R2	79.2956
Copper plate (Corrosion Testing)	Orytech Copper	J1	C3, R1	82.1146
		J2	C3, R2	82.4953
		I5	C7, R1	82.2547
		I6	C7, R2	82.6098
Aluminium plate (Corrosion Testing)	Orytech Aluminium	J1	C4, R1	37.5470
		J2	C4, R2	37.6657
		I5	C8, R1	37.9333
		I6	C8, R2	37.9711

6 Supporting hardware and communication peripherals

Data Logger	Campbell CR1000 (OS:Std.32.03)
Communication	RS232 (115200) TCP/IP
Pakbus Address	771
Password Set	0
Modem and Antenna	Maestro M100 3G modem with Poynting antenna
Network Details	Service provider: Safaricom Phone number: +254 793 305 047
Modem Power Control	SW12V
Data Logger Clock	GMT+3
Main Battery	2 x 12 V / 24 Ah
Solar Panel(s)	2 x 25 W
Charge Controller	2 x CPL Research (10 A)

7 Data logger wiring

E.Africa Wiring Diagram November 2019							
Logger Port	Accessories	Connection	Instrument Cable	Function	Reading	Instrument	
C8		1H	White	Signal +	GHI1	SR20	
		1L	Green	Signal -			
		AGB	Black	Shield			
	Relay 1 NO		Yellow	Heater +			
	VX3	10kΩ 0.1% Resistor	GB	Brown			Heater -
			SE3	Pink			Temp +
			AG1	Grey			Temp +
				Blue			Temp -
			3H	White / Red			Signal +
			3L	Green / Blue			Signal -
AGB			Black	GND			
Relay 1 NO				Yellow	Heater +		
VX1	10kΩ 0.1% Resistor	GB		Heater -			
		SE4	Red	Temp +			
		AG2	Blue	Temp -	GHI2	SR20 / CMP	
		5H	White	GHI +			
		6H	Brown	DHI +			
		5L	Green	Signal -			
		6L					
		GB	Grey	0 V			
		PB	Pink	12 V			
		Relay 1 NO		Red			Heater +
		GB	Blue	Heater -			
		AGB	Clear	GND			
		NC	Yellow	Sun	DHI	SPN1	
		PB	Red	12 V			
		C1	Green	Signal +			
		GB	White	0 V			
		GB	Black	0 V			
		AGB	Clear	GND			
		SE13	Red	Signal +			
		AG6	Blue	Signal -			
		AGB	Black	GND			
				SE14			Red
AG7	Blue			Signal -			
AGB	Black			GND			
SE15	Red			Signal +			
		AG7	Blue	Signal -	Clean	Ref cell	
		AGB	Black	GND			
		SE16	Red	Signal +			
		AG8	White	Signal -	Monthly	Ref cell	
		AGB	Clear	GND			
		P1	Black	Signal +			
		AG	White	Signal -	Dirty	Ref cell	
		AGB	Clear	GND			
		VX2	Black	Excitation			
		SE16	Red	Signal +	WD	024A	
		AG8	White	Signal -			
		AGB	Clear	GND			
		P1	Black	Signal +	WS	014A	
		AG	White	Signal -			
		AGB	Clear	GND			

Solar & Meteorological Station – Installation Report



		P2	Black	Signal +	Rain	TE525
		AG	White	Signal -		
		AGB	Clear	GND		
5V	10kΩ Resistor	C2	Red	Signal +	Clean	Clean Button
		C5	Green	Light +		
		C3	Blue	Signal -		
		AGB	Clear	GND		
5V	10kΩ Resistor	C4	Yellow	Signal +	Monthly	Monthly Button
		C5	Green	Light +		
		C3	Blue	Signal -		
		AGB	Clear	GND		
5V	10kΩ Resistor	C6	Red	Signal +	Gate	Switch
		G	Blue	Signal -		
		AGB	Clear	GND		
		SE4	Blue/Brown	Signal +	Pressure	PTB110
		PB	Red	12V		
		C7	Green	Signal +		
		GB	Black	Signal -		
		AG	Yellow/White	GND		
		AGB	Clear	GND		

8 Power circuit diagram

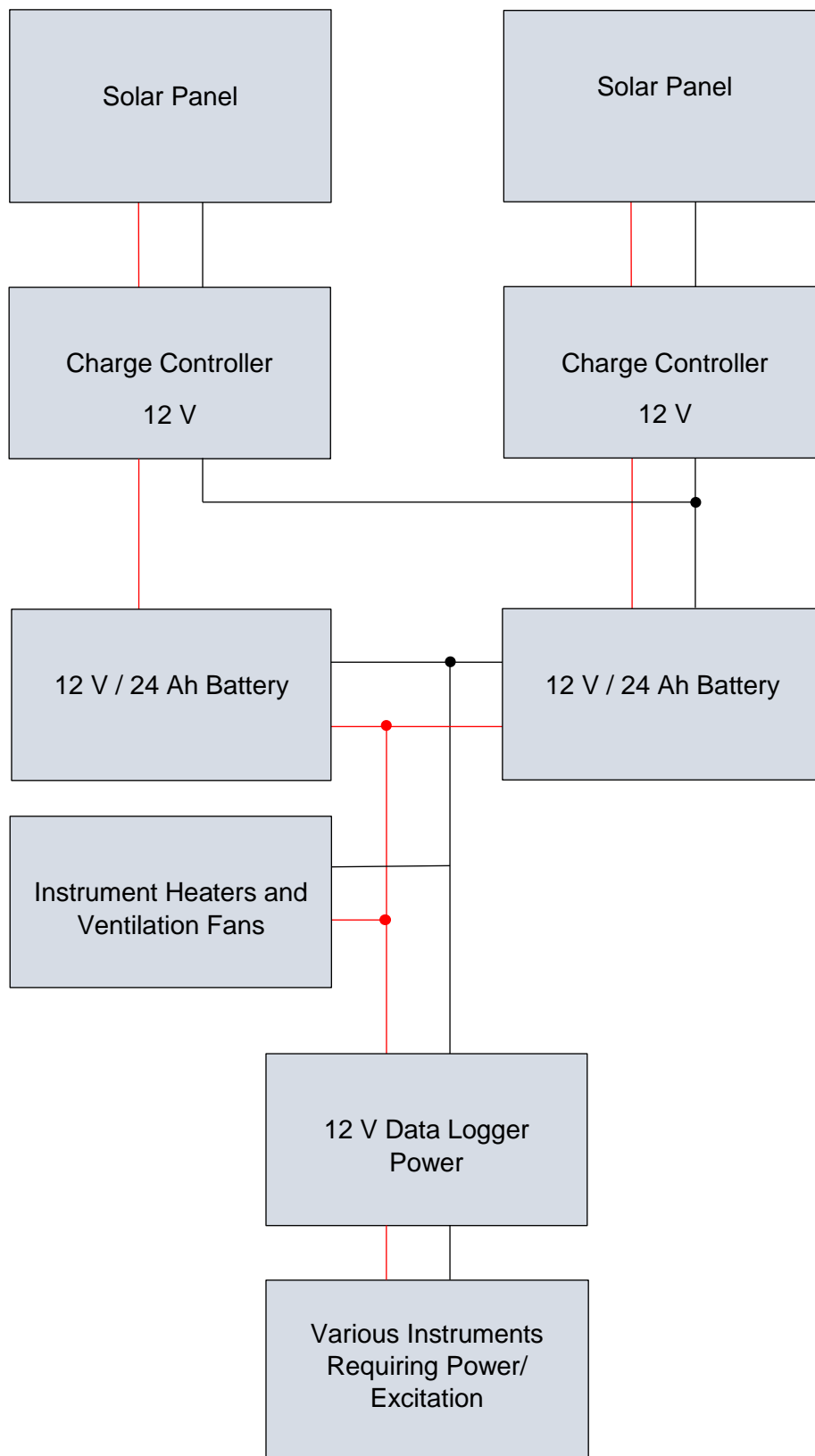

Figure 5: The DC power circuit

9 Detail Photographs

This section showcases details of the installation, including the main station components. Records are shown of instrument makes, models and serial numbers, as well as the installation levels and orientation where applicable.

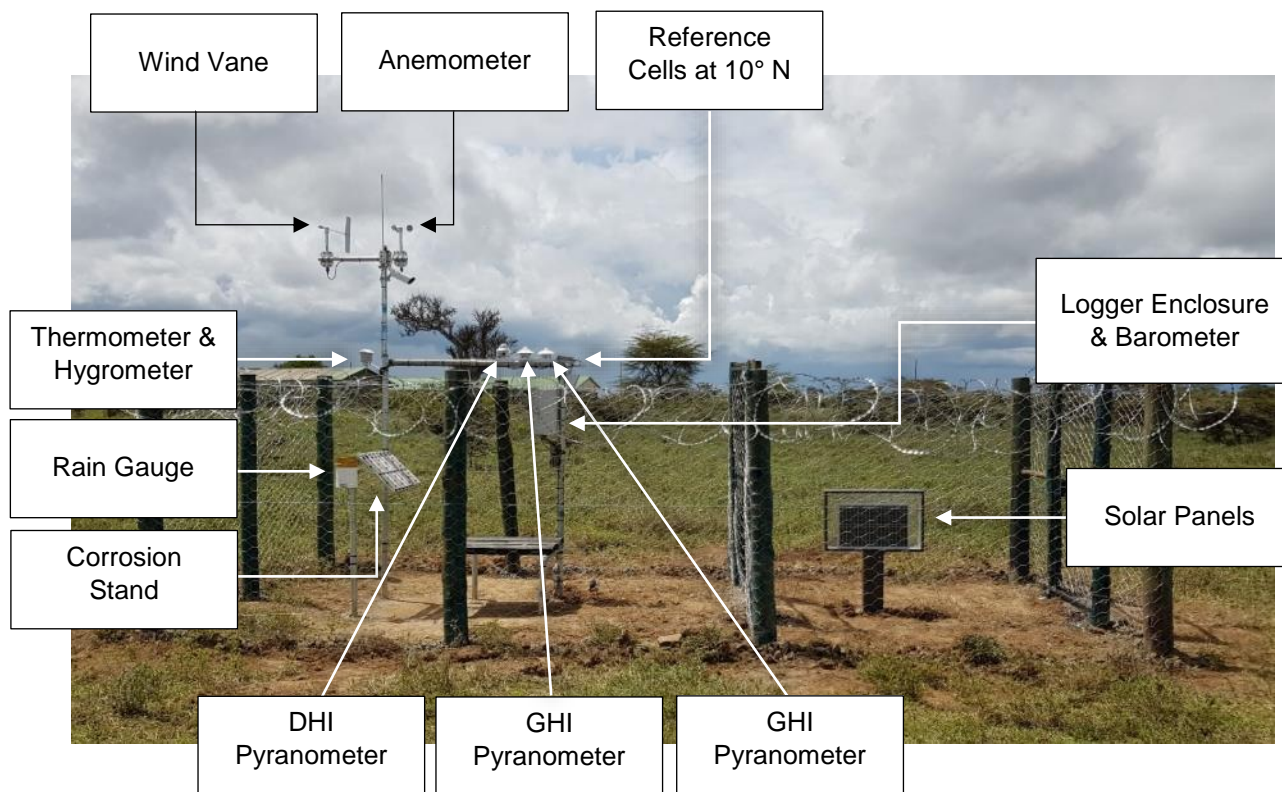

Figure 6: Station Summary



Figure 7: GHI (1) Pyranometer Installation



Figure 8: GHI (2) Pyranometer Installation



Figure 9: DHI Pyranometer Installation



Figure 10: Wind instruments at 3 m



Figure 11: Thermometer and Hygrometer at 2 m



Figure 12: Corrosion Test Stand



Figure 13: Rain Gauge

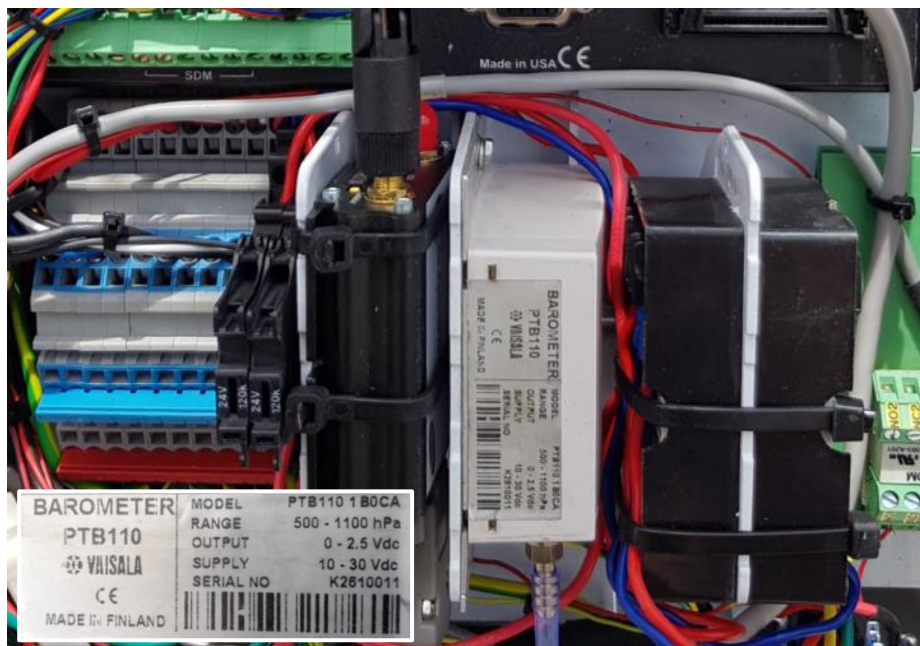

Figure 14: Barometer



Figure 15: Reference Cells at 10° North



Figure 16: Solar Panel



Figure 17: Logger Enclosure

10 Terrain Photographs

Obstacles protruding higher than the horizon as viewed from the solar instruments will affect lower solar elevation readings if they fall within the sun path as depicted in Figure 2. The pictures in this section shows the terrain surrounding the station at the time of installation, giving an indication of near or far shading influences on the station.



Figure 18: 0/360 Degrees (North)



Figure 19: 30 Degrees



Figure 20: 60 Degrees



Figure 21: 90 Degrees (East)



Figure 22: 120 Degrees



Figure 23: 150 Degrees



Figure 24: 180 Degrees (South)



Figure 25: 210 Degrees



Figure 26: 240 Degrees



Figure 27: 270 Degrees (West)



Figure 28: 300 Degrees



Figure 29: 330 Degrees

11 Station Photographs

This section indicates the station within the surrounding terrain to give an overall view thereof, as well as provide additional context to the possible near and far shading influences.



Figure 30: 0/360 Degrees (From North)



Figure 31: 30 Degrees



Figure 32: 60 Degrees



Figure 33: 90 Degrees (From East)



Figure 34: 120 Degrees



Figure 35: 150 Degrees



Figure 36: 180 Degrees (From South)



Figure 37: 210 Degrees



Figure 38: 240 Degrees



Figure 39: 270 Degrees (From West)



Figure 40: 300 Degrees



Figure 41: 330 Degrees

12 Calibration Certificates

Calibration Certificate

Pyranometer ISO 9847 Calibration
Certificate Number: GSACA-0822
Calibrated Instrument

Instrument: Pyranometer
 Manufacturer: Hukseflux
 Model: SR20-T2
 ISO 9060:1990 Class: Secondary Standard

Calibration Date: 06 August 2019
 Serial Number: 7276
 New Sensitivity: 13.26 $\mu\text{V}/\text{W}/\text{m}^2$

Calibration Methodology

GeoSUN performed an indoor calibration through exposure of both the calibrated instrument (instrument under test) and a reference instrument to an artificial light as radiation source and comparing the sensor outputs. The instruments were installed on a common horizontal base and regularly checked to ensure that it remained clean and level for the duration of the reference data being collected. The calibration was performed in accordance with the ISO 9847 (1992) standard, procedure type IIc.

Reference Instrument and its Traceability

The reference instrument is a Hukseflux SR20 pyranometer (SN 4978). The instrument was calibrated on 15 August 2018 at ISO-CAL North America against absolute cavity radiometer AHF-28560 which successfully participated at IPC-XII with the World Standard Group of radiometers. The location of ISO-CAL is at 20th street, Phoenix, Arizona in the USA at latitude 33.8176944°, longitude -112.0396083° and altitude 570 m AMSL. The reference instrument was calibrated at normal incidence with the sun and sky radiation as the source using the "alternating sun-and-shade method". The readings are referenced to the World Radiometric Reference (WRR) as stated in the WMO Technical Regulations, originally with an SI relative uncertainty estimated at $\pm 0.3\%$. The diagram on the right shows the traceability hierarchy.

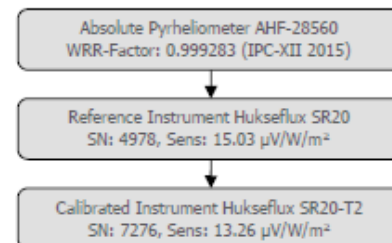
Absolute Uncertainty

The absolute uncertainty is the combined result of three uncertainties namely:

- 1) The expanded uncertainty during calibration of the reference instrument, given as $\pm 0.44\%$.
 - 2) The uncertainty in the correction of directional errors (cosine errors), estimated by scientific judgement as $\pm 0.5\%$.
 - 3) The expanded uncertainty of the transfer procedure (calibration by comparison), estimated by scientific judgement as $\pm 1\%$.
- The combined expanded uncertainty is the root sum of the squares, resulting in $\sqrt{(0.44^2 + 0.5^2 + 1^2)} = \pm 1.20\%$.

Calibration Environment, Results and Instrument Status

The calibration was performed at latitude -33.965467° , longitude 18.836348° and altitude 134 m AMSL and was concluded on 06 August 2019 at 14:35. A calibration was done using the measured output of the test instrument, of which the calibration environment and results are stated below. The measurement results recorded in this certificate were correct at the time of calibration. The subsequent accuracy will depend on factors such as care, handling and frequency of use. The calibration certificate or report may not be reproduced except in full, without the written approval of the laboratory. Considering the operating conditions and the IEC 61724-1:2017 standard requirements, GeoSUN recommends an annual calibration.

Instrument Status

Bubble Level: Good
 Dome: Good
 Desiccant: Good

Calibration Environment - Average [Range]

Irradiation: 569 [522 - 616] W/m^2
 Ambient Temperature: 21.8 [21.7 - 22.0] $^\circ\text{C}$
 Reference Instrument Temp.: 22.4 [22.1 - 22.6] $^\circ\text{C}$

Original Calibration

Original Sensitivity: 13.24 $\mu\text{V}/\text{W}/\text{m}^2$
 Original Calib. Date: 19 June 2017

Calibration Results

New Sensitivity: 13.25601 $\mu\text{V}/\text{W}/\text{m}^2$
 Sensitivity Standard Deviation (σ_{n-1}): 0.00370 $\mu\text{V}/\text{W}/\text{m}^2$
 Calibration Uncertainty ($k = 2$): $\pm 0.1593 \mu\text{V}/\text{W}/\text{m}^2$ ($\pm 1.20\%$)
 Data Quantity: 4 Series, 16 Samples
 Next Calibration: August 2020

Calibrated by:
 W.C. Engelbrecht



Authorised by:
 M.L. de Jager

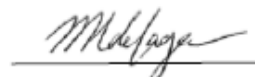

GeoSUN Africa (Pty) Ltd
 Unit 1, CS Africa Building, 1 Meson Street, Techno Park, Stellenbosch, South Africa
 info@geosun.co.za, www.geosun.co.za, +27 21 882 8354

V2019/07/16
 Page 1 of 1
 End of certificate

Calibration Certificate



Pyranometer ISO 9847 Calibration Certificate Number: GSACA-0815

<p>Calibrated Instrument Instrument: Pyranometer Manufacturer: Kipp & Zonen Model: CMP11 ISO 9060:1990 Class: Secondary Standard</p>	<p>Calibration Date: 06 August 2019 Serial Number: 128639 New Sensitivity: 8.30 $\mu\text{V}/\text{W}/\text{m}^2$</p>
---	--

Calibration Methodology

GeoSUN performed an indoor calibration through exposure of both the calibrated instrument (instrument under test) and a reference instrument to an artificial light as radiation source and comparing the sensor outputs. The instruments were installed on a common horizontal base and regularly checked to ensure that it remained clean and level for the duration of the reference data being collected. The calibration was performed in accordance with the ISO 9847 (1992) standard, procedure type IIc.

Reference Instrument and its Traceability

The reference instrument is a Kipp & Zonen CMP21 pyranometer (SN 110811). The instrument was calibrated on 14 August 2018 at ISO-CAL North America against absolute cavity radiometer AHF-28560 which successfully participated at IPC-XII with the World Standard Group of radiometers. The location of ISO-CAL is at 20th street, Phoenix, Arizona in the USA at latitude 33.8176944°, longitude -112.0396083° and altitude 570 m AMSL. The reference instrument was calibrated at normal incidence with the sun and sky radiation as the source using the "alternating sun-and-shade method". The readings are referenced to the World Radiometric Reference (WRR) as stated in the WMO Technical Regulations, originally with an SI relative uncertainty estimated at $\pm 0.3\%$. The diagram on the right shows the traceability hierarchy.

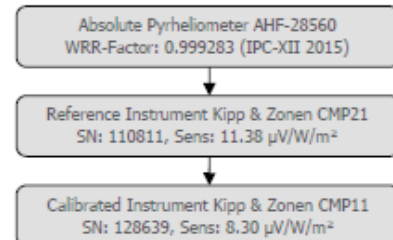

Absolute Uncertainty

The absolute uncertainty is the combined result of three uncertainties namely:

- 1) The expanded uncertainty during calibration of the reference instrument, given as $\pm 0.44\%$.
- 2) The uncertainty in the correction of directional errors (cosine errors), estimated by scientific judgement as $\pm 0.5\%$.
- 3) The expanded uncertainty of the transfer procedure (calibration by comparison), estimated by scientific judgement as $\pm 1\%$.

The combined expanded uncertainty is the root sum of the squares, resulting in $\sqrt{(0.44^2 + 0.5^2 + 1^2)} = \pm 1.20\%$.

Calibration Environment, Results and Instrument Status

The calibration was performed at latitude -33.965467° , longitude 18.836348° and altitude 134 m AMSL and was concluded on 06 August 2019 at 08:07. A calibration was done using the measured output of the test instrument, of which the calibration environment and results are stated below. The measurement results recorded in this certificate were correct at the time of calibration. The subsequent accuracy will depend on factors such as care, handling and frequency of use. The calibration certificate or report may not be reproduced except in full, without the written approval of the laboratory. Considering the operating conditions and the IEC 61724-1:2017 standard requirements, GeoSUN recommends an annual calibration.

Instrument Status

Bubble Level: Good
 Dome: Good
 Desiccant: Replaced

Calibration Environment - Average [Range]

Irradiation: 576 [551 - 600] W/m^2
 Ambient Temperature: 18.2 [17.8 - 18.6] $^\circ\text{C}$
 Reference Instrument Temp.: 18.7 [18.1 - 19.2] $^\circ\text{C}$

Original Calibration

Original Sensitivity: 8.29 $\mu\text{V}/\text{W}/\text{m}^2$
 Original Calib. Date: 01 November 2012

Calibration Results

New Sensitivity: 8.30197 $\mu\text{V}/\text{W}/\text{m}^2$
 Sensitivity Standard Deviation (σ_{n-1}): 0.00412 $\mu\text{V}/\text{W}/\text{m}^2$
 Calibration Uncertainty ($k = 2$): $\pm 0.0997 \mu\text{V}/\text{W}/\text{m}^2 (\pm 1.20\%)$
 Data Quantity : 4 Series, 16 Samples
 Next Calibration: August 2020

Calibrated by:
 W.C. Engelbrecht

Authorised by:
 M.L. de Jager



GeoSUN Africa (Pty) Ltd
 Unit 1, CS Africa Building, 1 Meson Street, Techno Park, Stellenbosch, South Africa
 info@geosun.co.za, www.geosun.co.za, +27 21 882 8354

V2019/07/16
 Page 1 of 1
 End of certificate

Calibration Certificate



ISO 9001 Meteorological Calibration

Calibration Number: GSACM-0056

Station Name: Narok Meteorological Station
Location: -33.965447°, 18.8361658°

Calibration Date: 07 November 2019
Ambient conditions: 18 - 19 °C; 70 - 65 % RH

Test Instrument	Parameter	Reference Reading	Test Reading	Uncertainty (±)*	
				Instr.	Absolute
Campbell Scientific Model CS215 SN E11086	Ambient Temperature	1.6 °C 44.9 °C	1.4 °C 45.1 °C	0.9 °C	1.9 °C
Campbell Scientific Model CS215 SN E11086	Relative Humidity At 20°C → At 20°C →	21.7 % RH 71.5 % RH	22.0 %RH 71.6 %RH	2 % RH	5.6 % RH
Vaisala PTB110 SN K2610011	Barometric Pressure	602.2 hPa 701.2 hPa 801.0 hPa 1001.5 hPa	601.7 hPa 700.8 hPa 800.5 hPa 1001.1 hPa	1.5 hPa	2.7 hPa
Met One Model 014A SN U11172	Wind Speed 200 rpm → 400 rpm → $m/s = (rpm \times 0.02667) + 0.447$ 800 rpm → 1 800 rpm → 2 400 rpm →	5.8 m/s 11.1 m/s 21.8 m/s 48.4 m/s 64.4 m/s	5.6 m/s 11.2 m/s 21.6 m/s 48.4 m/s 64.4 m/s	1 m/s	1.0 m/s
Met One Model 024A SN U11205	Wind direction	North East South West	0 ° 90 ° 180 ° 270 °	5 °	10 °
Texas electronics model TE-525I SN 56803-813	Precipitation $Tips = \frac{ml}{4.73 ml/Tip}$	250 ml 52 Tips	53 Tips	7.5 ml 1 Tip	11.5 ml 2 Tips

Comments: The rain gauge sensitivity was adjusted.

Reference Instruments

Parameter	Reference Instrument	Serial Number	Traceability	Calibration Date	Uncertainty (±)	
					Instr.	Expanded*
Temperature	Campbell Scientific 109	15553-29	South African National Standard (NMISA)	05-Sep-19	0.01	1.02 °C
Relative Humidity	Rotronic HC2A-SH	20261232	Swiss National Standard (Rotronic)	03-Sep-19	1.1	3.6 % RH
Barometric Pressure	Vaisala PTB110	L2850725	South African National Standard (Inteltronics)	09-Sep-19	0.2	1.2 hPa
Precipitation	Glassco Measuring Cyl.	05.15/2028	Indian National Standard (Glassco)	19-Sep-19	3	4.02 ml
Wind Speed	Young 18802 Drive	4664	South African National Standard (LabCom)	28-Aug-19	2	3 rpm

* Expanded uncertainty includes the reference's accuracy and calibration uncertainty, and this calibration's transfer uncertainty. Absolute calibration uncertainty includes the test instrument accuracy. Although the test instrument increment resolution can have an effect on the uncertainty, it is not taken into account.

Calibration Methodology

Temperature:	Reference and test instruments were sealed and submerged in warm and cold water sources for respective measurements.
Relative Humidity:	Reference and test instruments were tested in a low humidity chamber and at ambient conditions.
Barometric Pressure:	Reference and test instruments were connected to a closed pressure system and different pressures were induced.
Precipitation:	A set volume of water was poured through the rain gauge at an acceptable flow rate and the amount of tips were counted.
Wind Speed:	A drive was coupled to the anemometer shaft, set rotational speeds were applied and wind speed recorded.
Wind Direction:	The wind vane was handheld at roughly 90° increment angles while angle outputs were recorded.

 Calibrated by:
 W.C. Engelbrecht



 Approved by:
 M.L. de Jager



 GeoSUN Africa (Pty) Ltd
 Unit 1, CS Africa Building, 1 Meson Street, Techno Park, Stellenbosch, South Africa
 info@geosun.co.za, www.geosun.co.za, +27 21 882 8354

2018/06/16

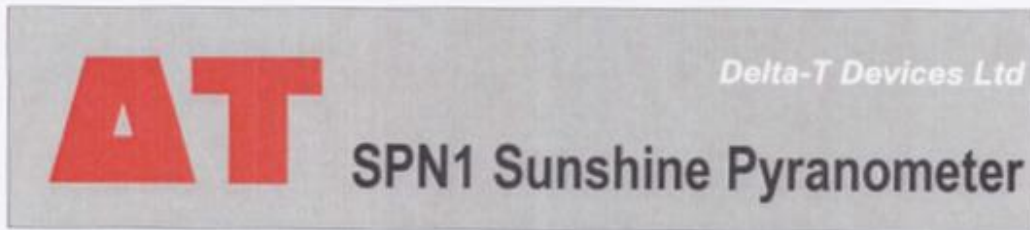

Calibration Certificate

This is to certify that the Sunshine Pyranometer type SPN1 identified below has been calibrated in accordance with Delta-T Devices Ltd standard production procedures and conforms to the specifications as detailed.

Serial Number	SPN1 – A1703
Date	10/05/19
Authorised Signature	

We recommend that this instrument is recalibrated every 2 years.

Traceability

The SPN1 is calibrated under a uniform light source which simulates the solar spectrum, against a transfer standard SPN1. The transfer standard is calibrated outdoors against a Kipp & Zonen CM21 secondary standard pyranometer (calibration traceable to the World Radiometric Reference), with solar tracker and shading disk for diffuse measurement.

Accuracy, Total (Global) and Diffuse radiation

When correctly calibrated, the expected accuracy is given in the table below. The figures give 95% confidence limits, i.e. 95% of individual readings will be within the stated limits under normal climatic conditions.

Overall accuracy:	±5% daily integrals ±5% ±10 W.m ⁻² hourly averages ±6% ±10 W.m ⁻² individual readings
Range	0 to >2000 W.m ⁻²
Analogue output sensitivity	1mV = 1 W.m ⁻²



Delta-T Devices Ltd
 130 Low Road, Burwell, Cambridge, CB25 0EJ, UK
 Tel: +44 1638 742922 Fax: +44 1638 743155
 email: sales@delta-t.co.uk web: www.delta-t.co.uk

SPN1 Service and Recalibration Report

R7227

SPN1 Serial Number: A1703	Serviced by: Jamie Patrick	Date: 16/05/19
---------------------------	----------------------------	----------------

Inspection

Inspect and clean... Condition, observations, actions taken

Dome Good.

Seal Good.

Shadow mask Good.

Bezel Bezel assembly replaced.

Diffusers Good.

Connectors Good.

Desiccant holder Good.

Desiccant Replaced desiccant capsule. Supplied spare.

Main o-ring seal Good.

General condition and observations Good. Normal wear and tear.

Recalibration

Calibration date : 10/05/19

Error before recalibration : 1.6%

SPN1-SR-01-02